



US00D566386S

(12) **United States Design Patent**
Linsenman

(10) **Patent No.:** **US D566,386 S**

(45) **Date of Patent:** **** Apr. 15, 2008**

(54) **HANDBAG HAVING A VOLLEYBALL SHAPE**

(76) Inventor: **Alexis Linsenman**, 16 Lone Elm Dr.,
St. Louis, MO (US) 63125

(**) Term: **14 Years**

(21) Appl. No.: **29/246,402**

(22) Filed: **Apr. 7, 2006**

(51) **LOC (8) Cl.** **03-01**

(52) **U.S. Cl.** **D3/238**

(58) **Field of Classification Search** D3/201,
D3/205, 230, 231, 233, 247, 251, 232, 234,
D3/238, 240-246, 303, 318-326, 900, 902,
D3/217, 216, 270, 271, 257, 258, 259; 150/100,
150/107-110, 118-120; 190/100, 108-112,
190/115, 900, 902, 903

See application file for complete search history.

(56) **References Cited**

U.S. PATENT DOCUMENTS

D229,793 S *	1/1974	Tibbs	D3/238
D229,871 S *	1/1974	Tibbs	D3/238
D231,586 S *	5/1974	Lazo	D3/238
D231,590 S *	5/1974	McKinney	D6/597
D232,130 S *	7/1974	Burkett	D3/238
D232,872 S *	9/1974	Ventimiglia	D3/246
D235,693 S *	7/1975	Tibbs	D3/238
D236,036 S *	7/1975	Tibbs	D3/238

D346,273 S *	4/1994	Lucas	D3/271.9
D362,960 S *	10/1995	Stein	D3/226
2007/0102460 A1 *	5/2007	Lottman	224/153

* cited by examiner

Primary Examiner—Joel A. Sincavage
Assistant Examiner—Michelle E Wilson

(74) *Attorney, Agent, or Firm*—Lewis, Rice & Fingersh,
L.C.

(57) **CLAIM**

The ornamental design for a handbag having a volleyball shape, as shown and described.

DESCRIPTION

FIG. 1 is a perspective view of a handbag having a volleyball shape, showing my new design;

FIG. 2 is a rear view thereof;

FIG. 3 is a front view thereof;

FIG. 4 is a left side view thereof;

FIG. 5 is a right side view thereof;

FIG. 6 is a top view thereof; and,

FIG. 7 is a bottom view thereof.

The broken lines showing handles used in conjunction with the handbag having a volleyball shape are for illustrative purposes only and form no part of the invention.

1 Claim, 7 Drawing Sheets

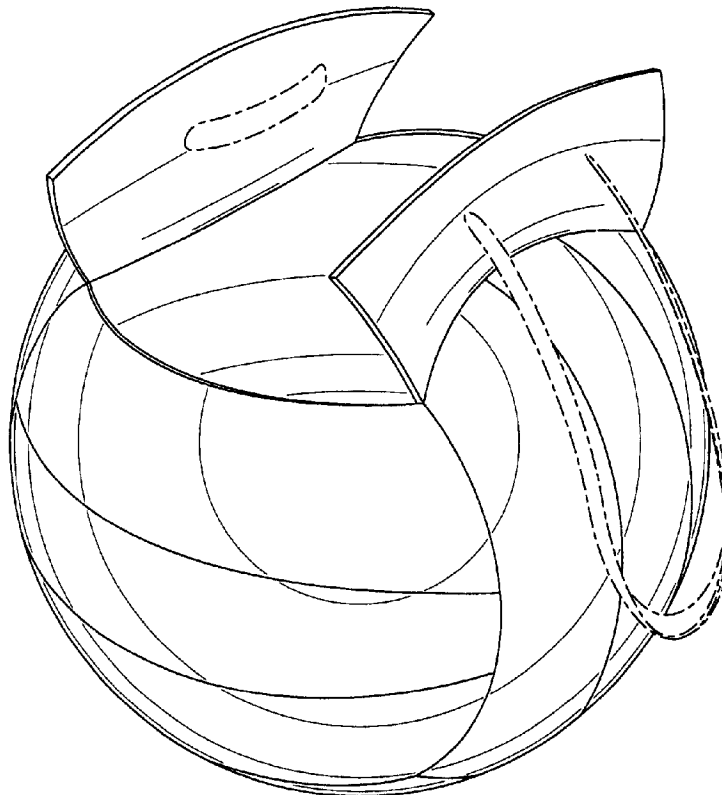

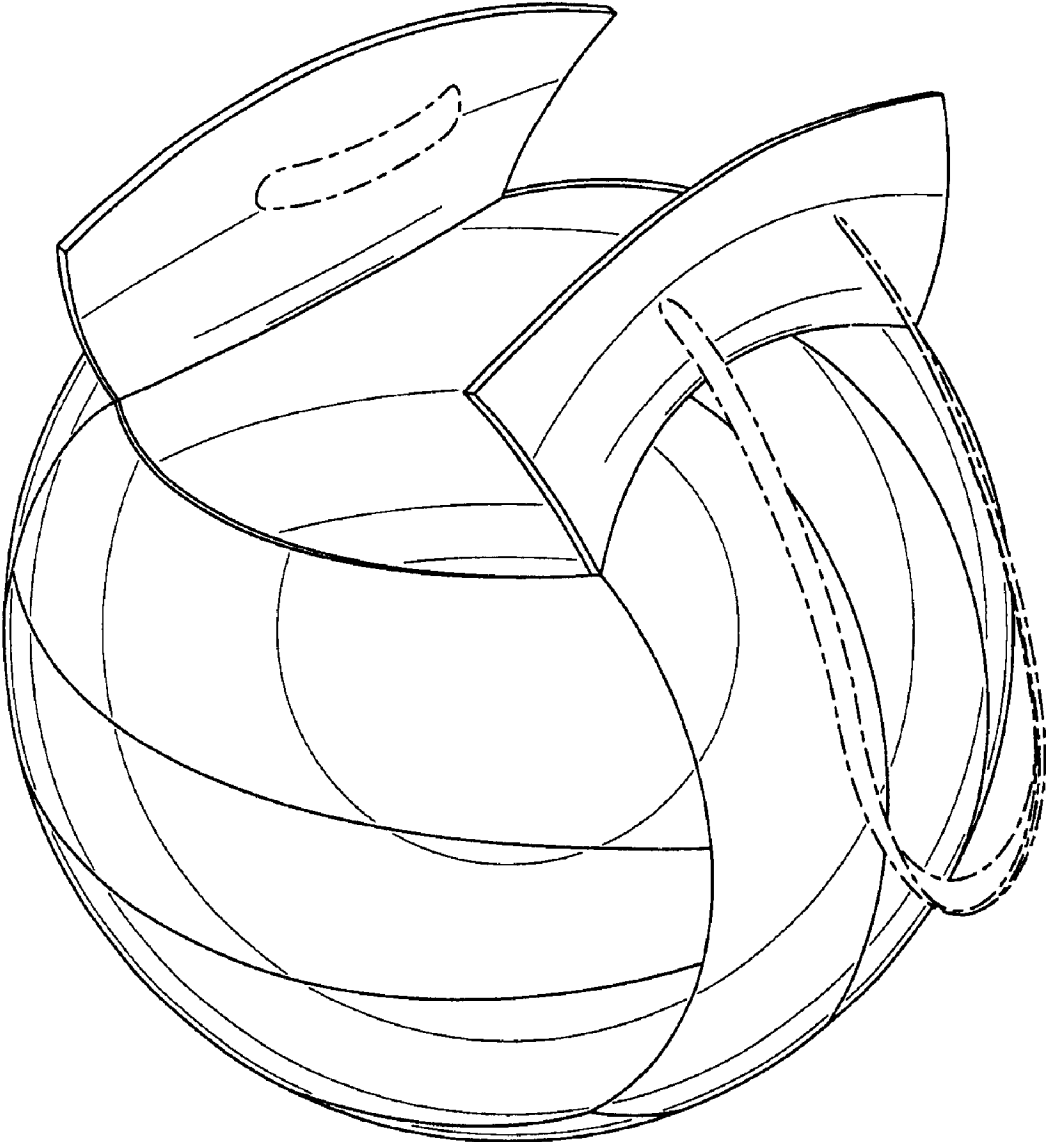

FIG. 1

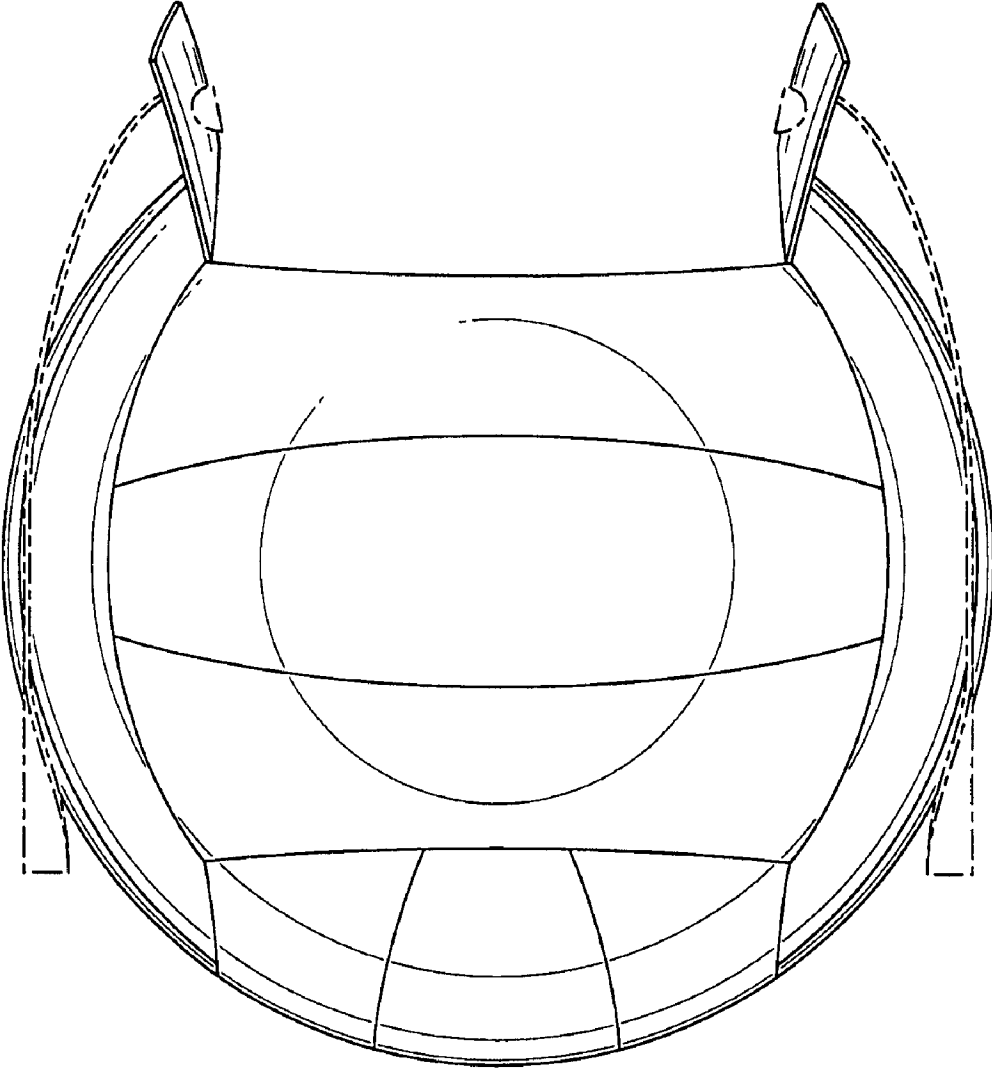

FIG. 2

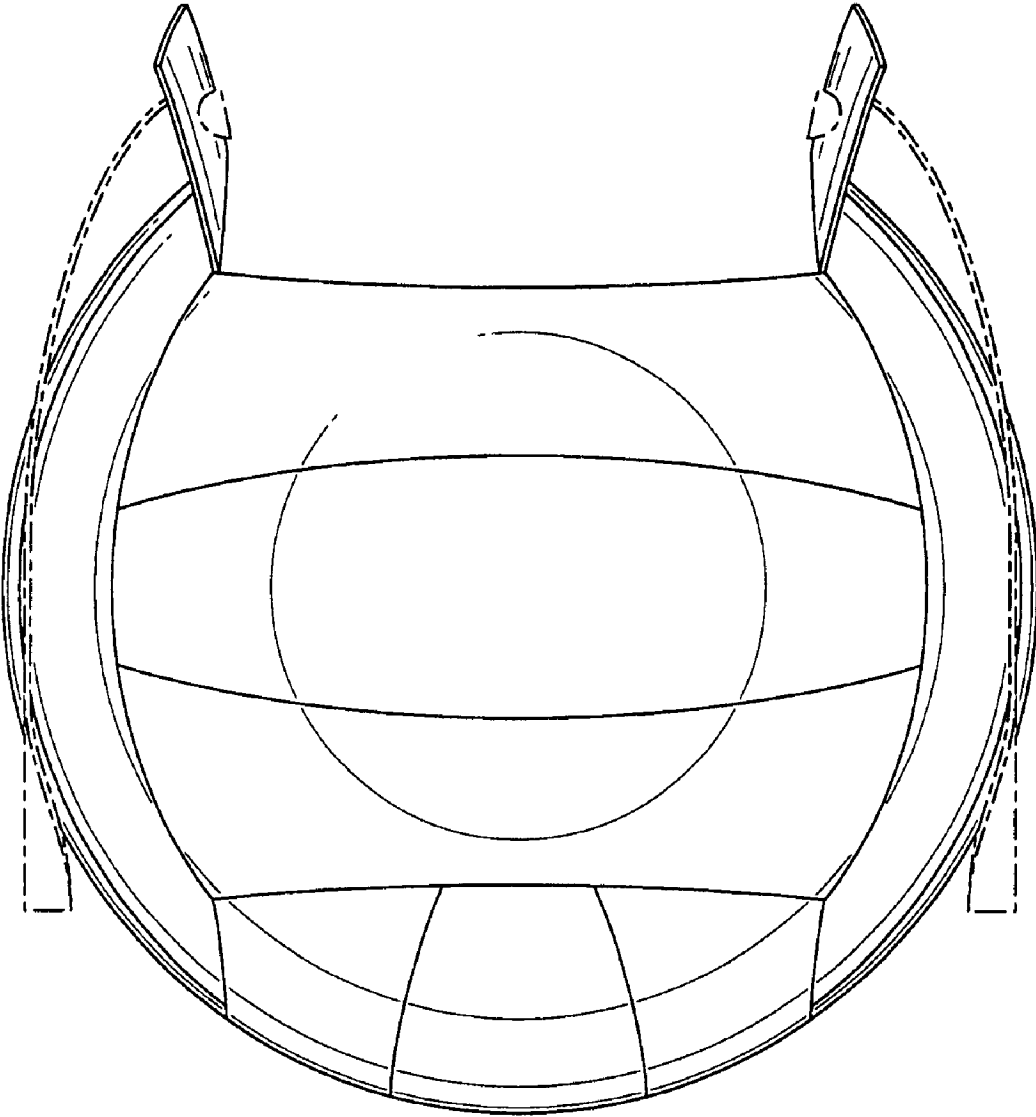

FIG. 3

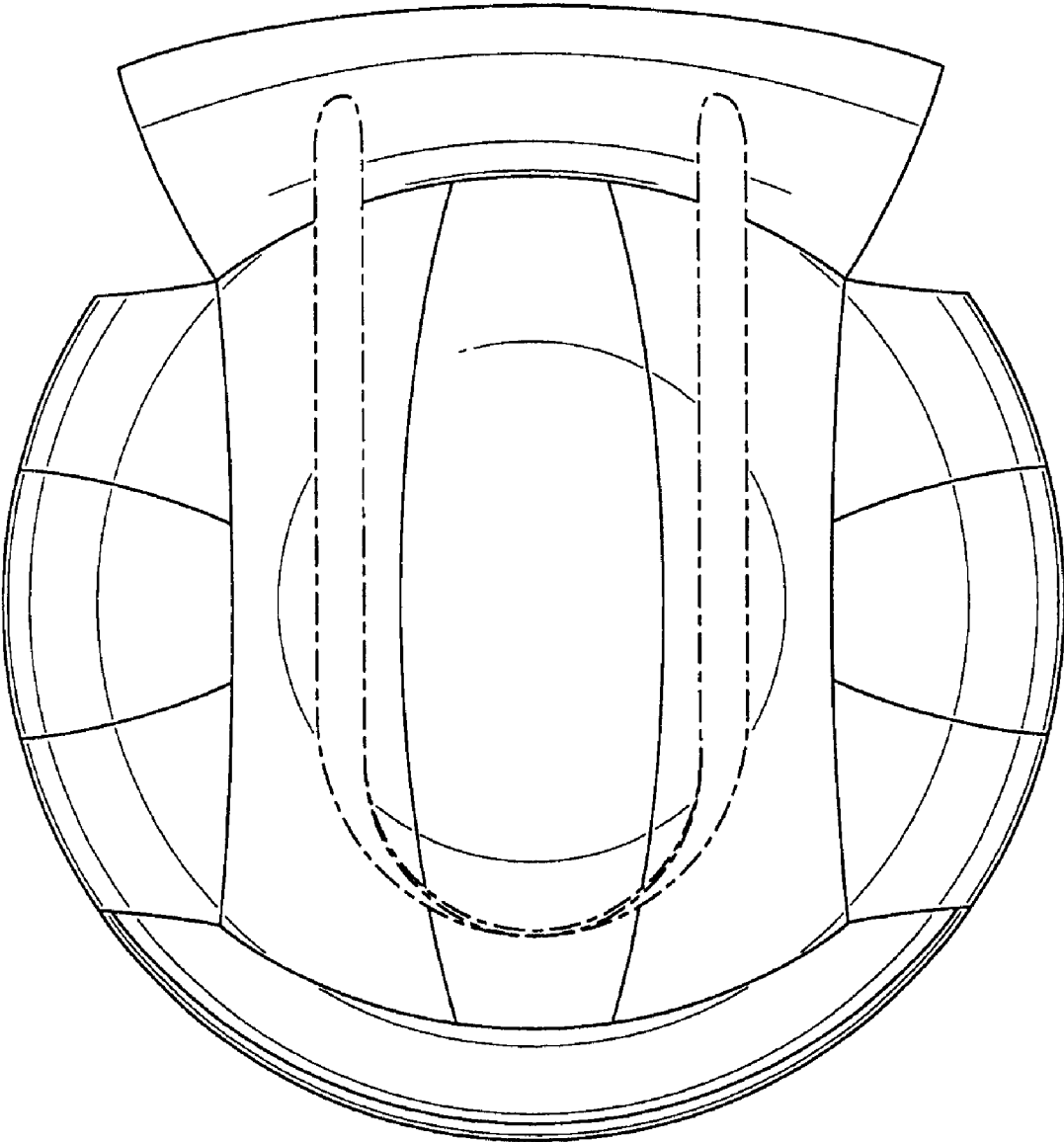

FIG. 4

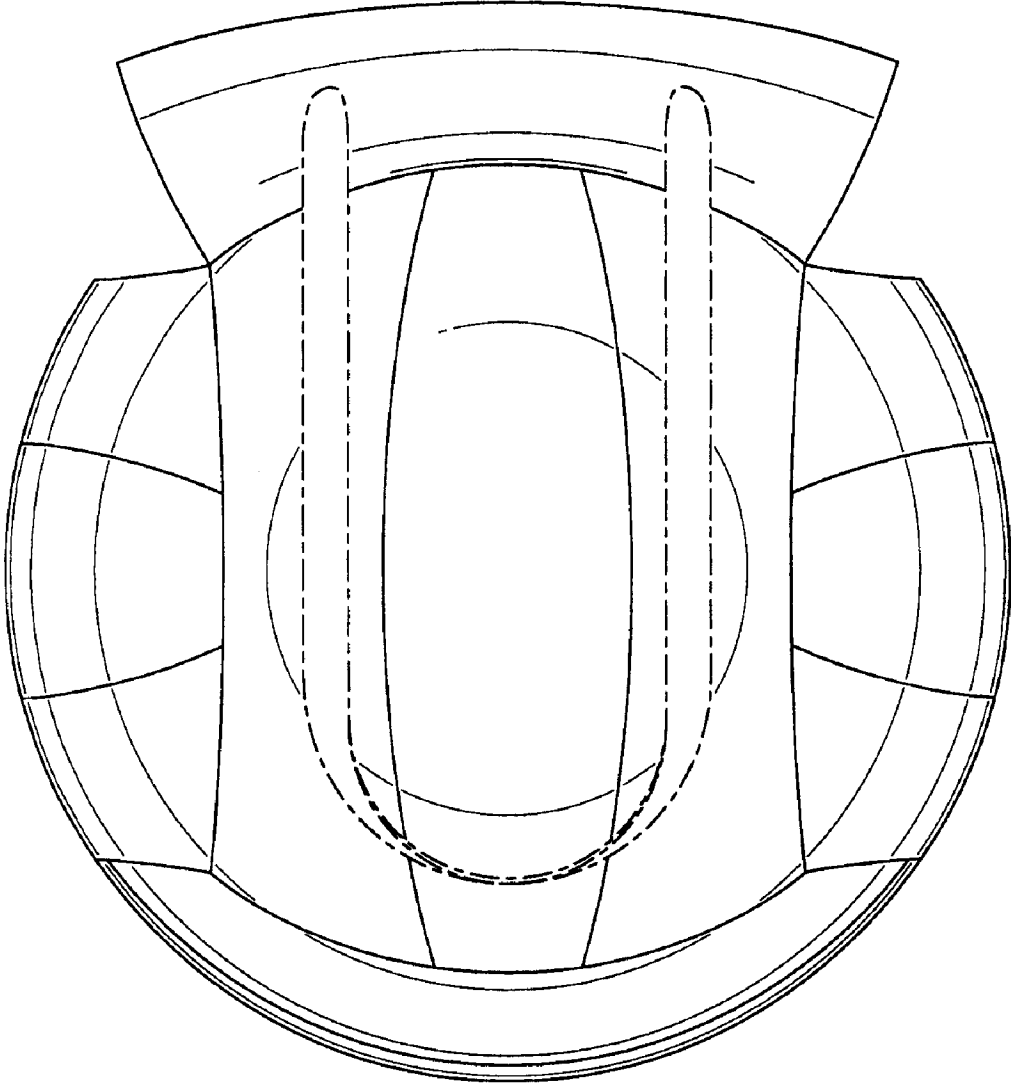

FIG. 5

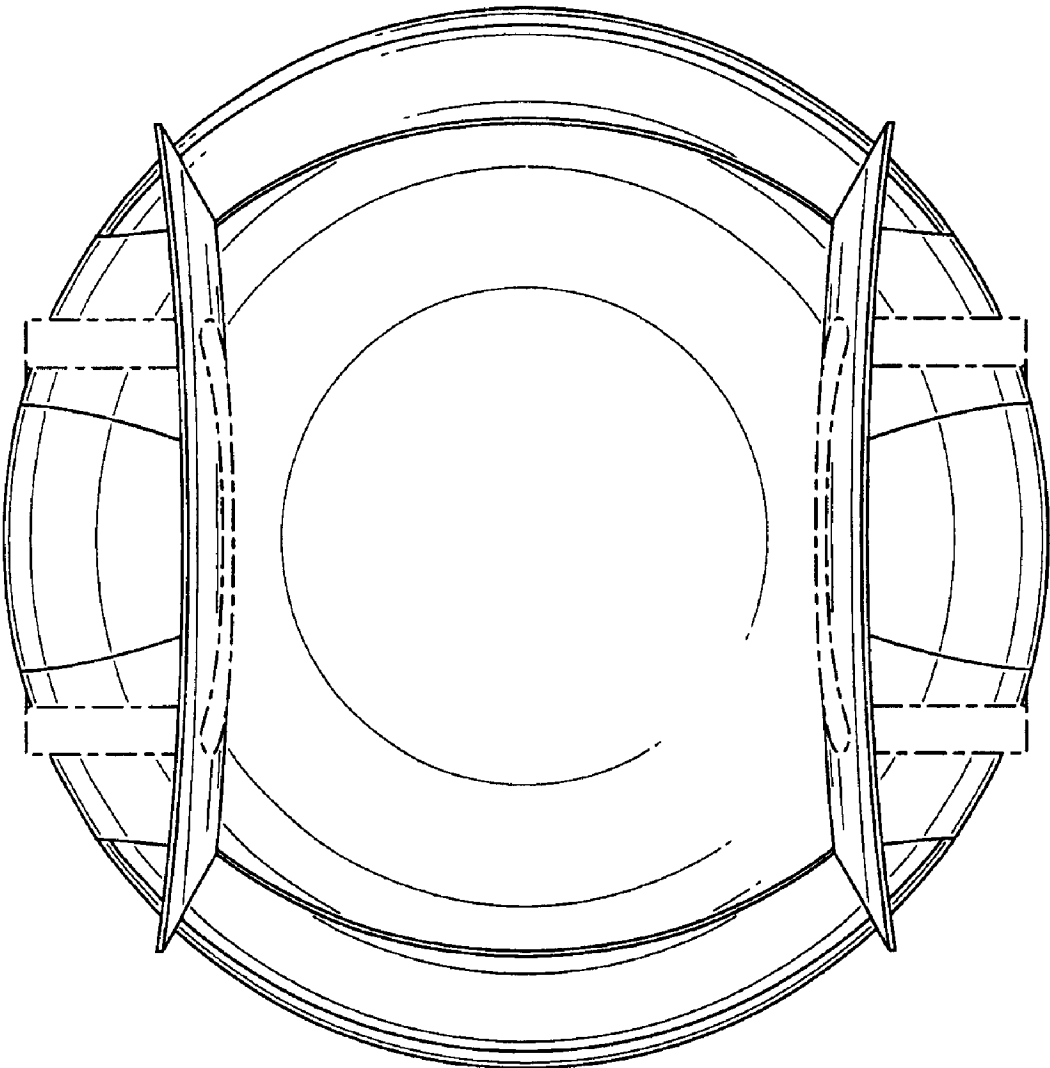

FIG. 6

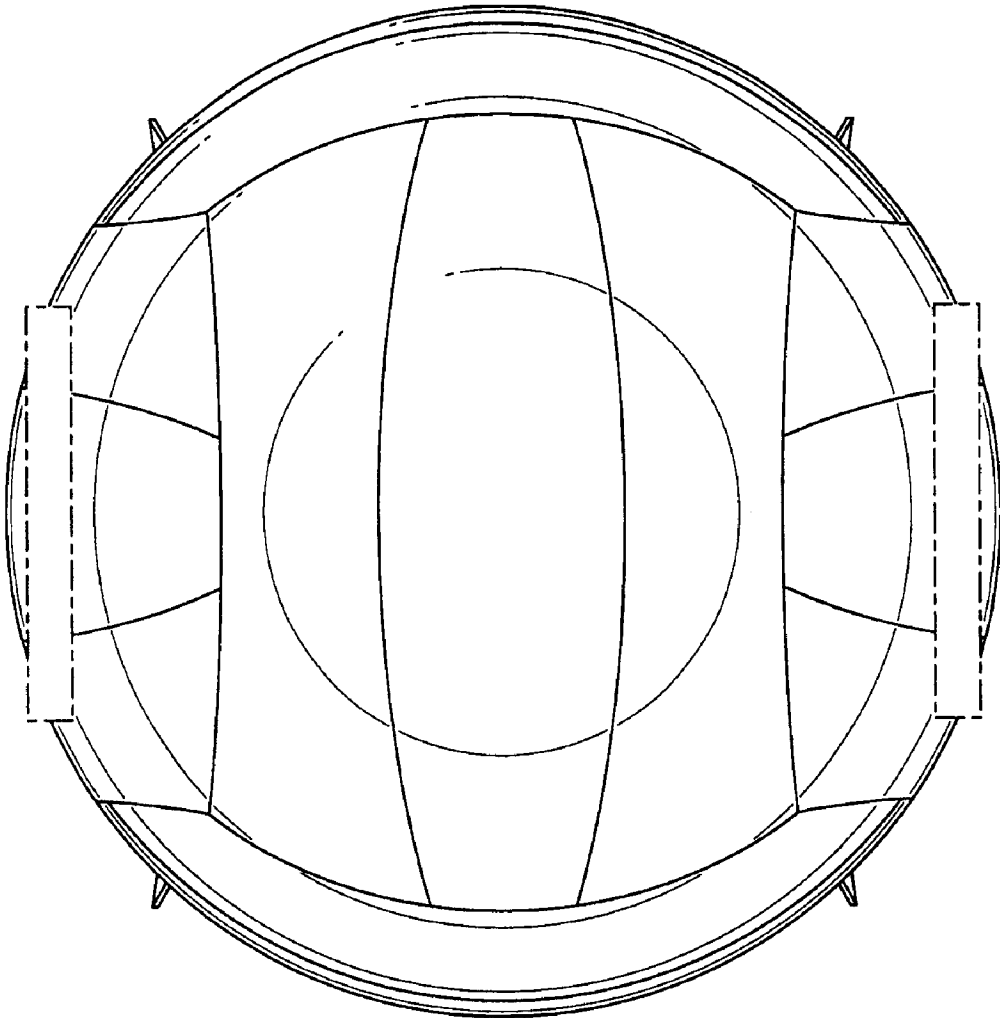

FIG. 7